

**LÉGENDE:**

- VENDU
- INVENTAIRE
- MODÈLE
- CONDITIONNEL

LÉGENDES ÉLECT.	
	TRANSFORMATEUR
	BOITE VIDEOTRON / BELL
	LAMPADAIRE
	COUVERCLE D'ACCÈS

**PHASE 9**

BOULEVARD DE L'AMÉRIQUE-FRANÇAISE

CHEMIN VANIER

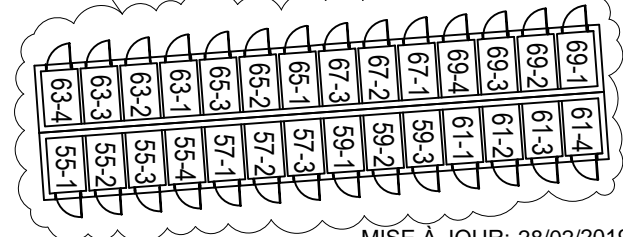
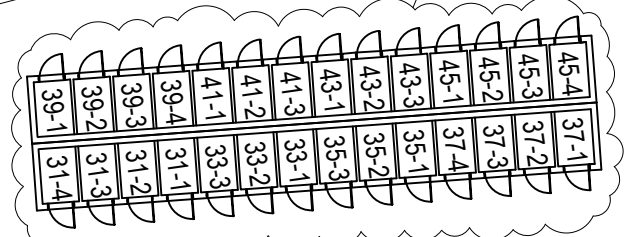
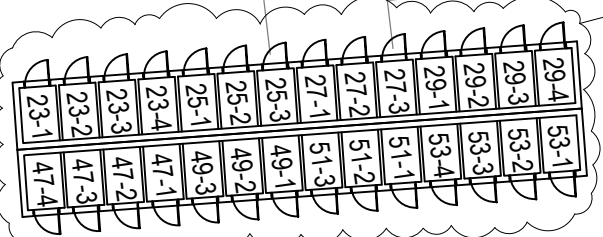
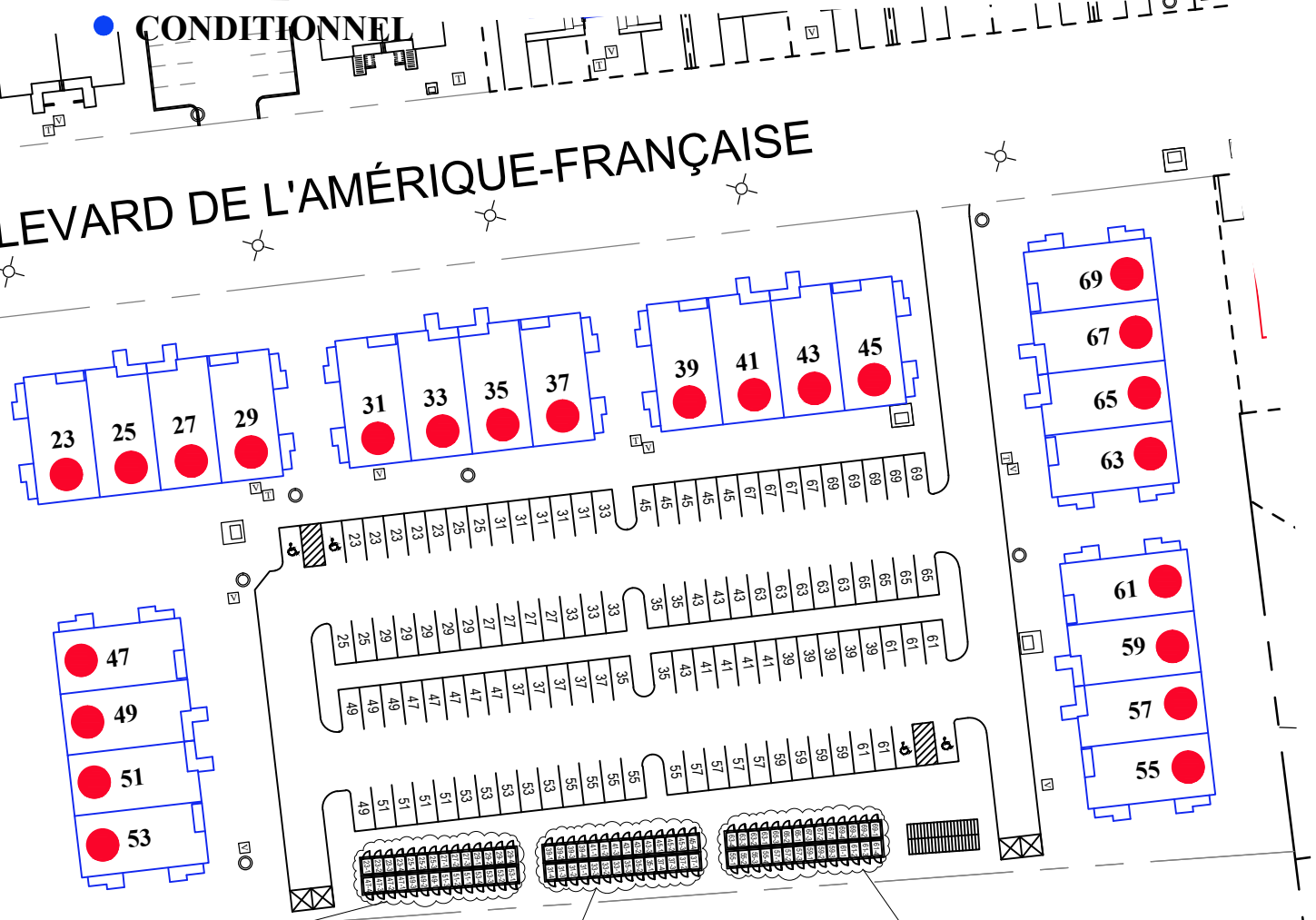

**PHASE 9**

LÉGENDES ÉLECT.	
	TRANSFORMATEUR
	BOITE VIDEOTRON / BELL
	LAMPADAIRE
	COUVERCLE D'ACCÈS

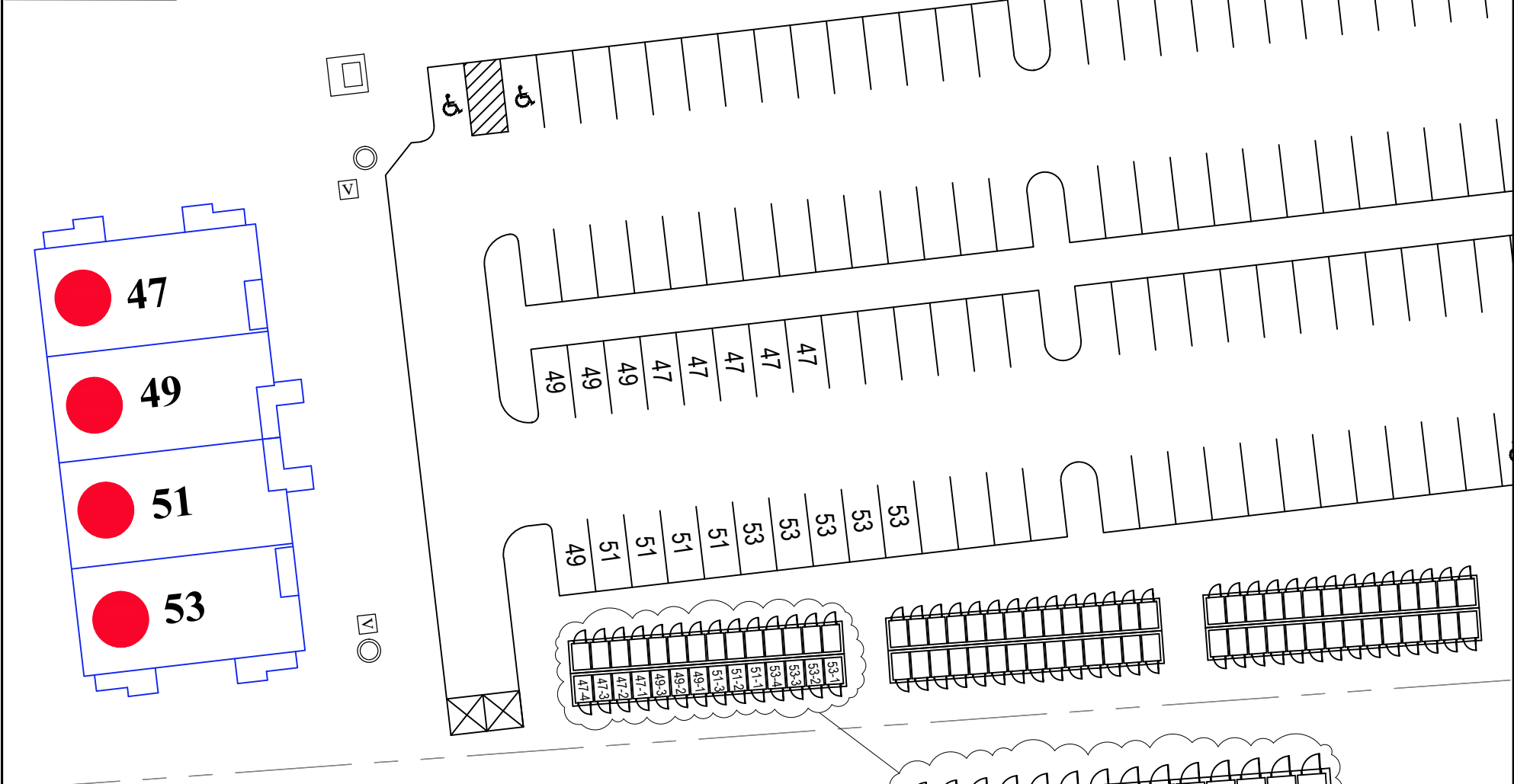





En signant le document, les clients confirment le choix de stationnements /  
 By signing this document, customers confirm the choice of parking.

Client: \_\_\_\_\_

Client: \_\_\_\_\_

Date: \_\_\_\_\_

**PHASE 9**

LÉGENDES ÉLECT.	
	TRANSFORMATEUR
	BOITE VIDEOTRON / BELL
	LAMPADAIRE
	COUVERCLE D'ACCÈS

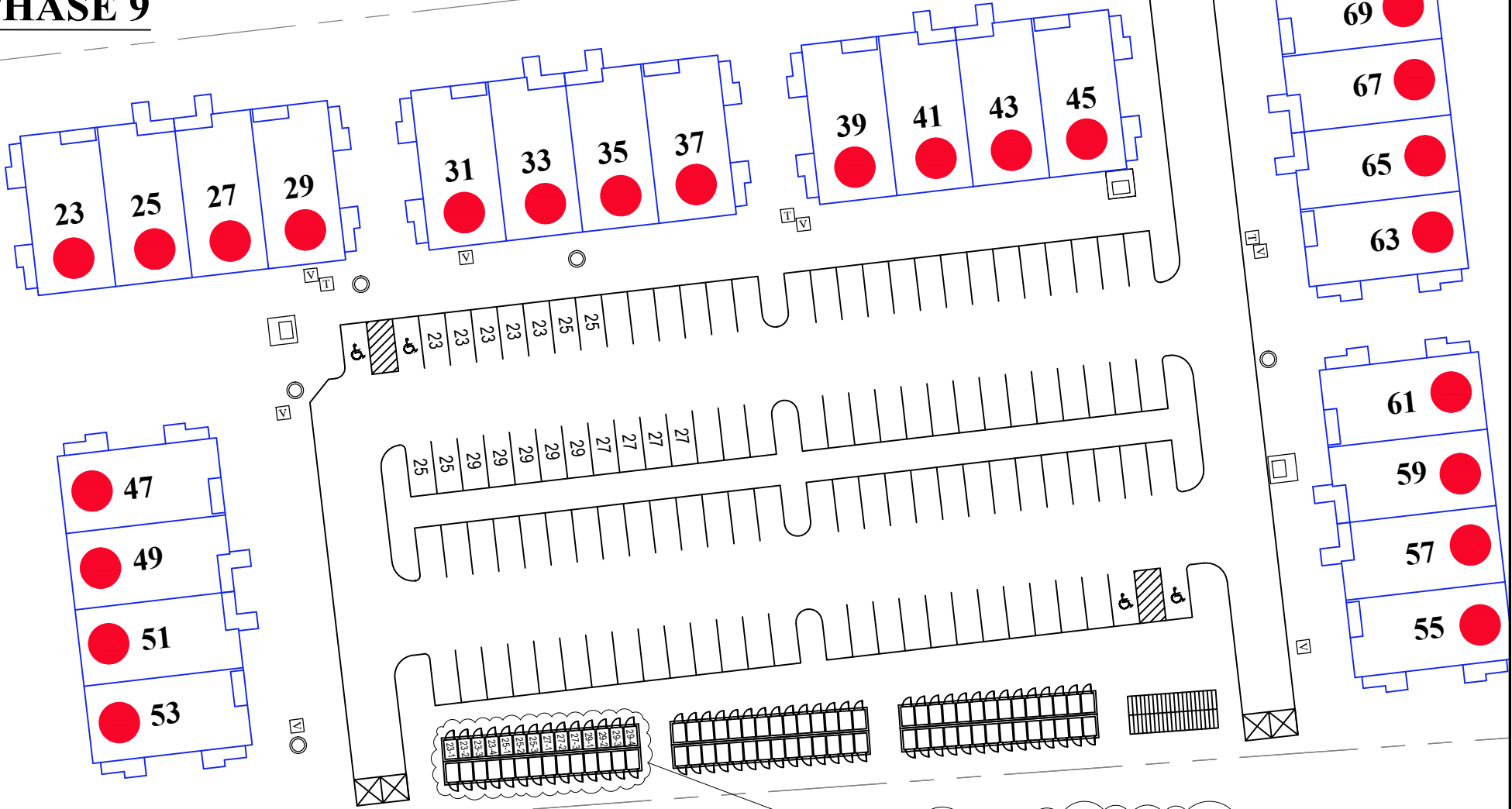

En signant le document, les clients confirment le choix de stationnements /  
 By signing this document, customers confirm the choice of parking.

Client: \_\_\_\_\_  
 Client: \_\_\_\_\_  
 Date: \_\_\_\_\_

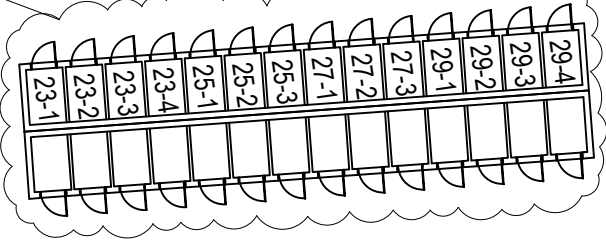

**PHASE 9**

LÉGENDES ÉLECT.	
	TRANSFORMATEUR
	BOITE VIDEOTRON / BELL
	LAMPADAIRE
	COUVERCLE D'ACCÈS

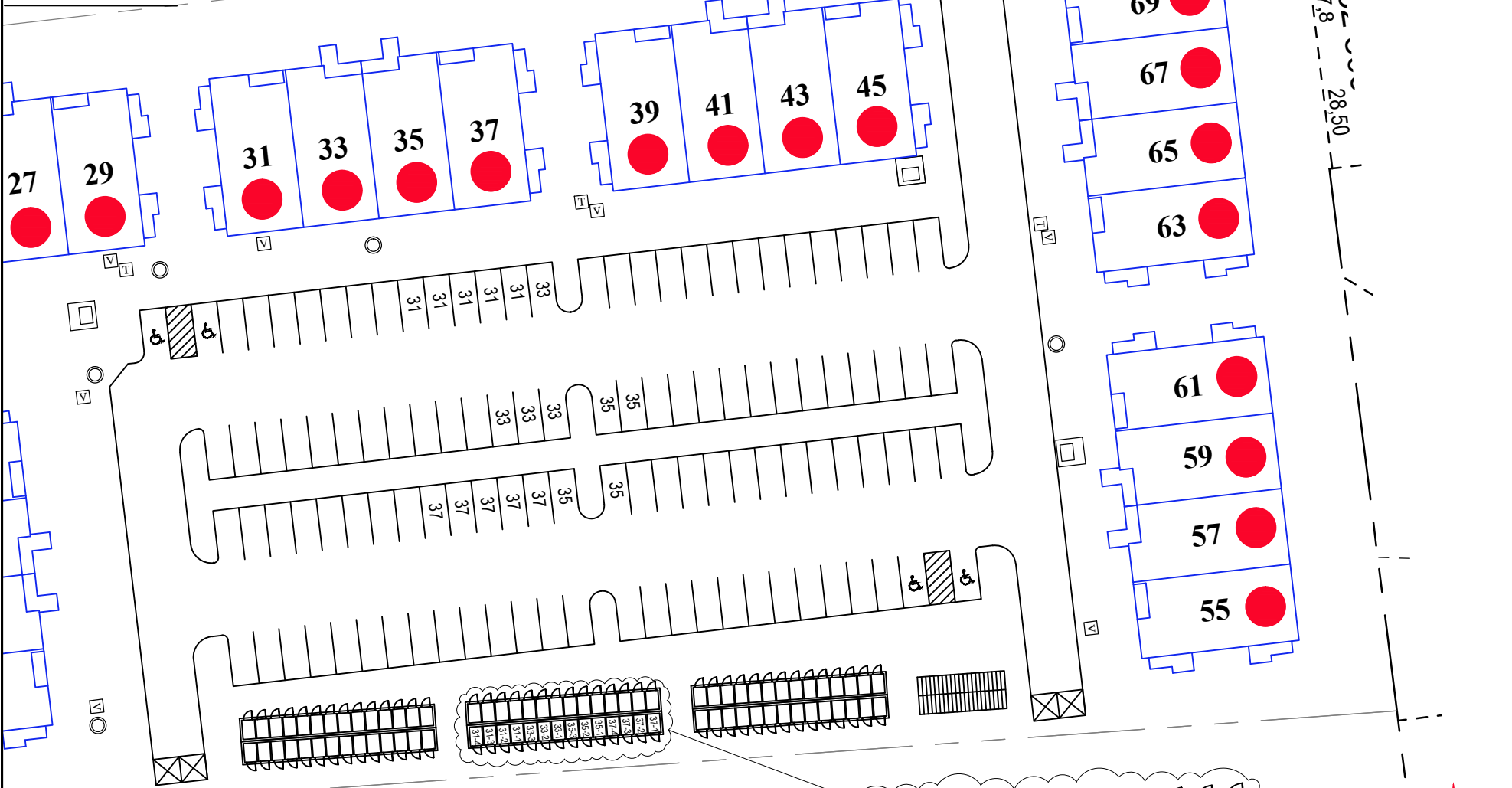

En signant le document, les clients confirment le choix de stationnements /  
 By signing this document, customers confirm the choice of parking.



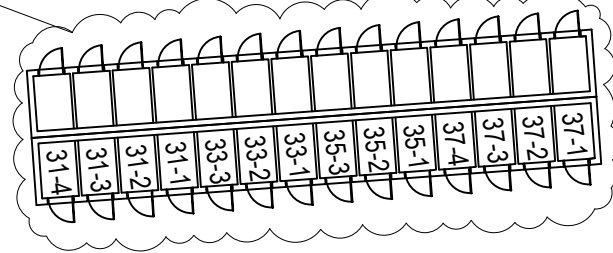

Client: \_\_\_\_\_

Client: \_\_\_\_\_

Date: \_\_\_\_\_





LÉGENDES ÉLECT.	
	TRANSFORMATEUR
	BOITE VIDEOTRON / BELL
	LAMPADAIRE
	COUVERCLE D'ACCÈS

# PHASE 9

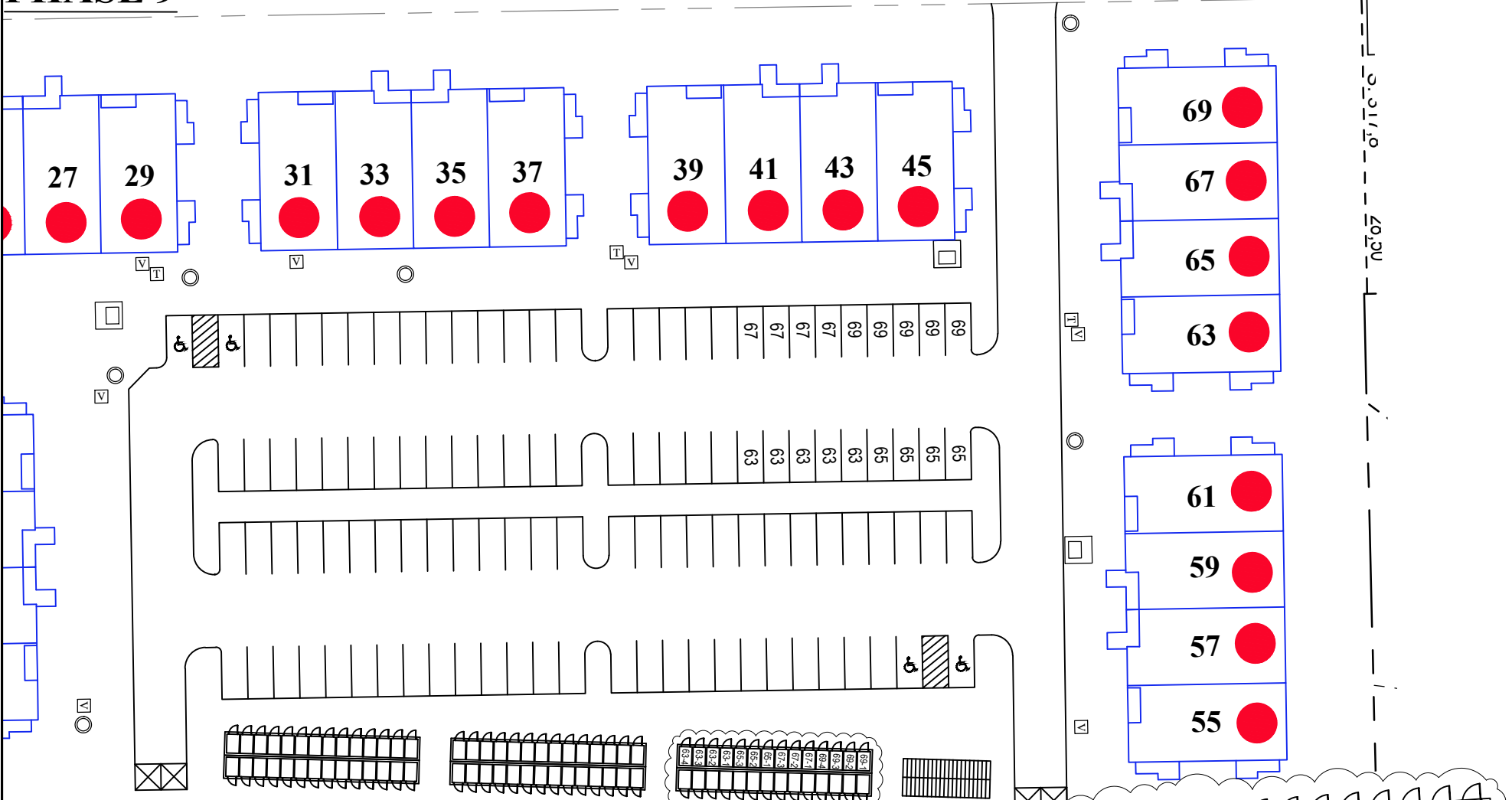





En signant le document, les clients confirment le choix de stationnements /  
 By signing this document, customers confirm the choice of parking.

Client: \_\_\_\_\_

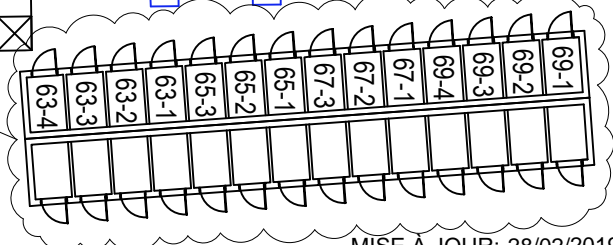
Client: \_\_\_\_\_

Date: \_\_\_\_\_



LÉGENDES ÉLECT.	
	TRANSFORMATEUR
	BOITE VIDEOTRON / BELL
	LAMPADAIRE
	COUVERCLE D'ACCÈS

**PHASE 9**

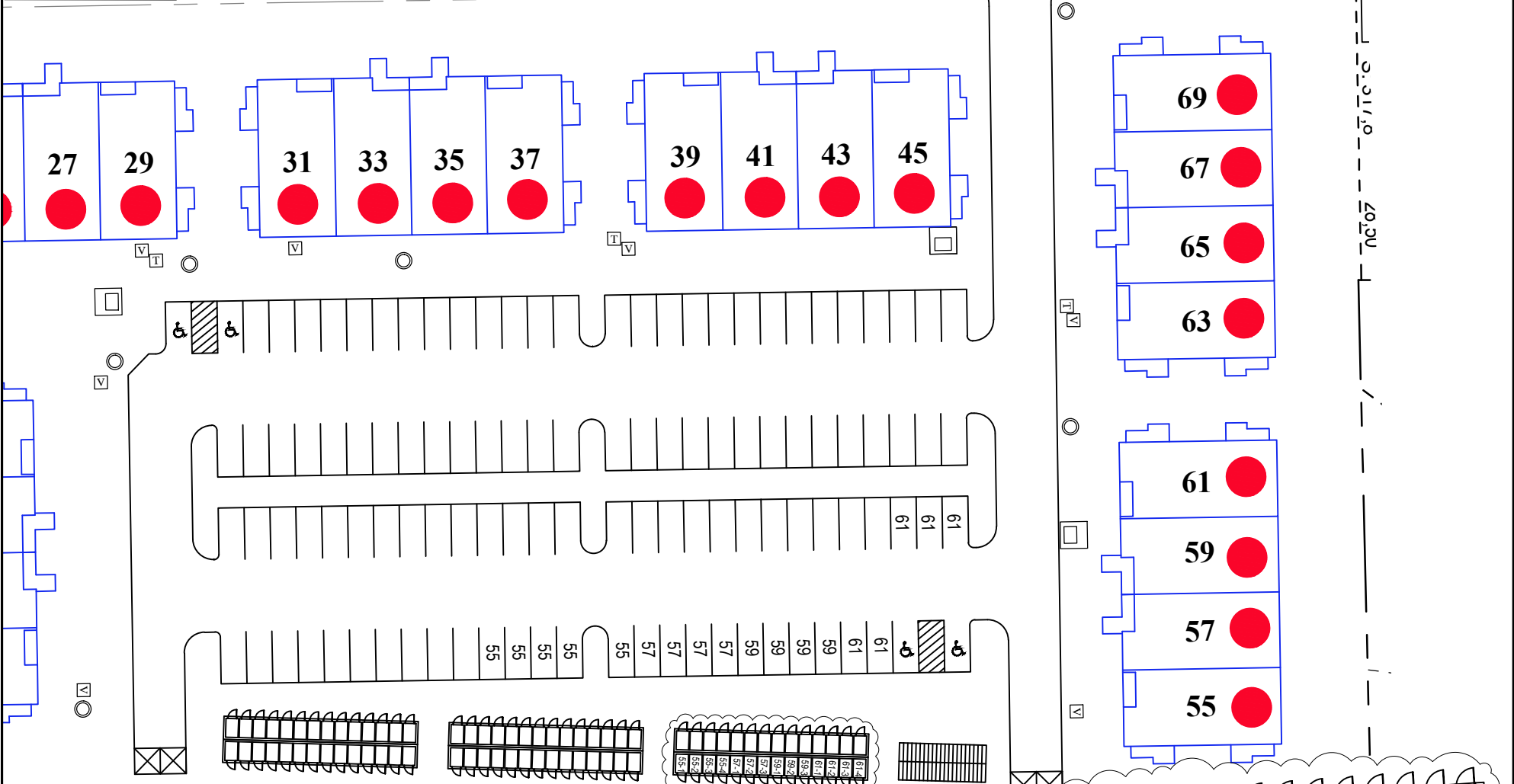

En signant le document, les clients confirment le choix de stationnements /  
 By signing this document, customers confirm the choice of parking.

Client: \_\_\_\_\_

Client: \_\_\_\_\_

Date: \_\_\_\_\_

