

LÉGENDE:

- VENDU
- INVENTAIRE
- MODÈLE
- CONDITIONNEL

LÉGENDES ÉLECT.	
	TRANSFORMATEUR
	BOITE VIDEOTRON / BELL
	LAMPADAIRE
	COUVERCLE D'ACCÈS

PHASE 9

BOULEVARD DE L'AMÉRIQUE-FRANÇAISE

CHEMIN VANIER

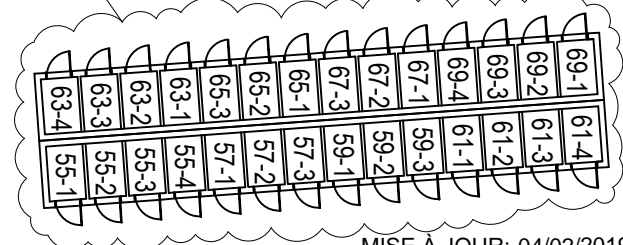
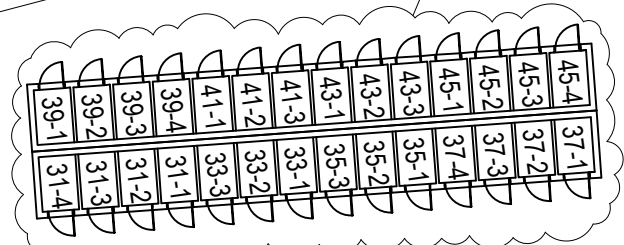
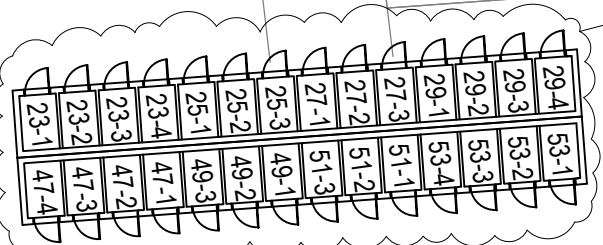
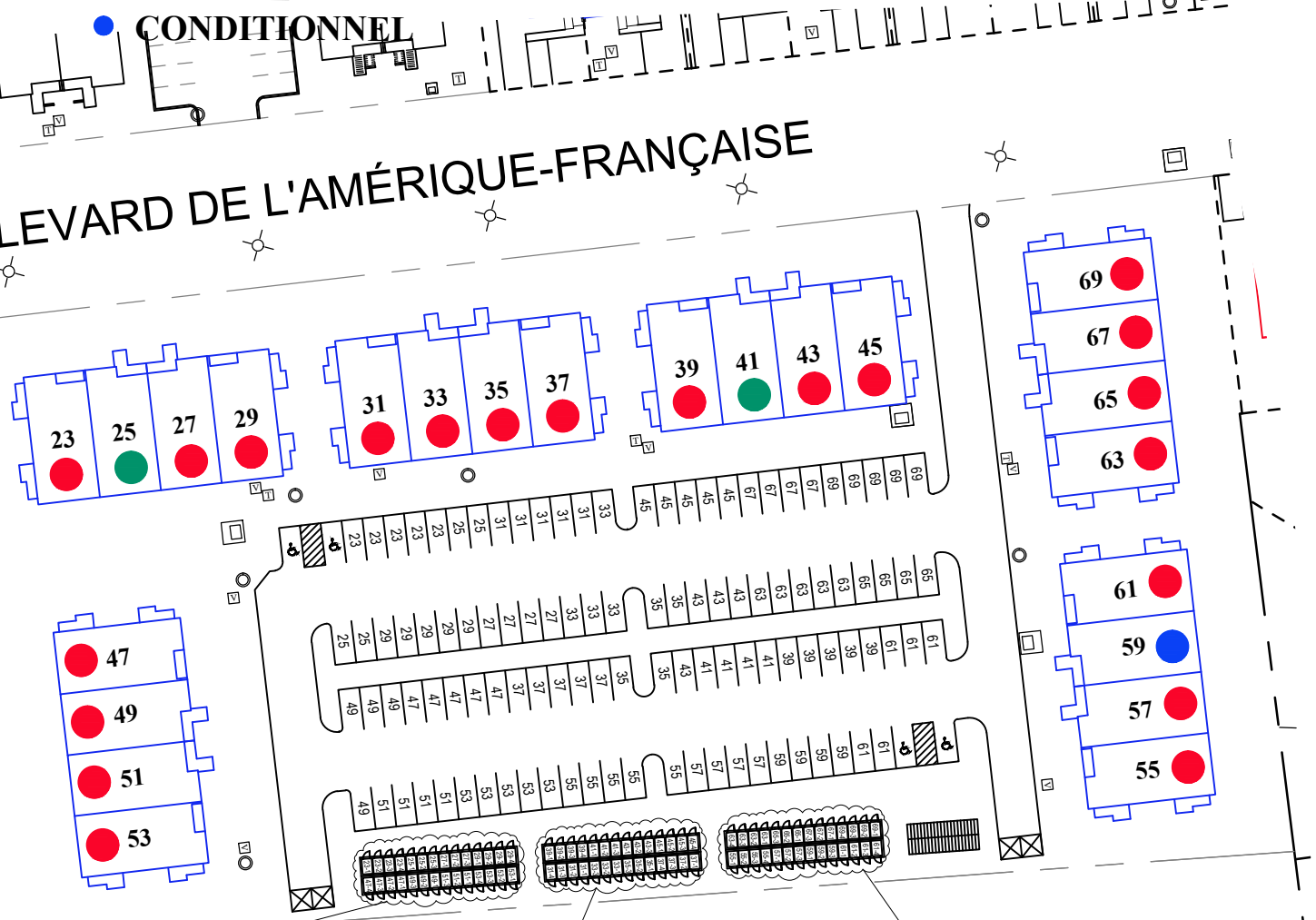

PHASE 9

LÉGENDES ÉLECT.	
	TRANSFORMATEUR
	BOITE VIDEOTRON / BELL
	LAMPADAIRE
	COUVERCLE D'ACCÈS

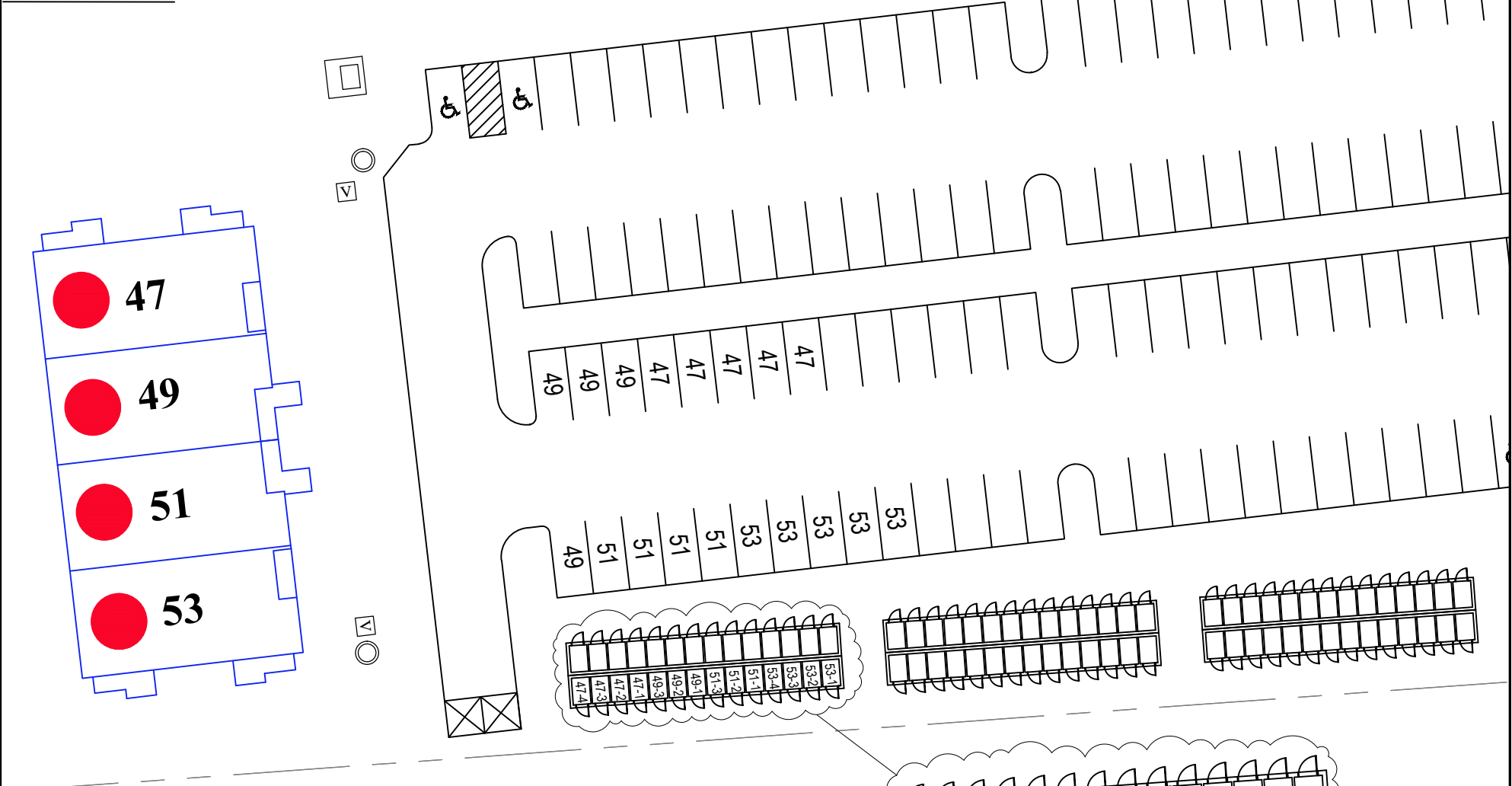

En signant le document, les clients confirment le choix de stationnements /
 By signing this document, customers confirm the choice of parking.

Client: _____

Client: _____

Date: _____

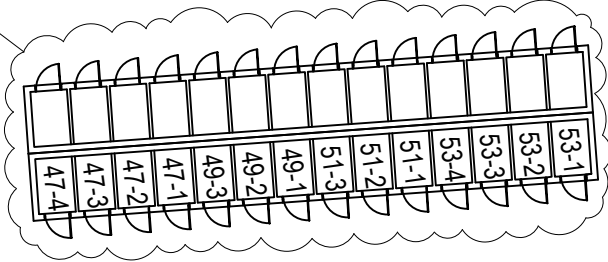

PHASE 9

LÉGENDES ÉLECT.	
	TRANSFORMATEUR
	BOITE VIDEOTRON / BELL
	LAMPADAIRE
	COUVERCLE D'ACCÈS

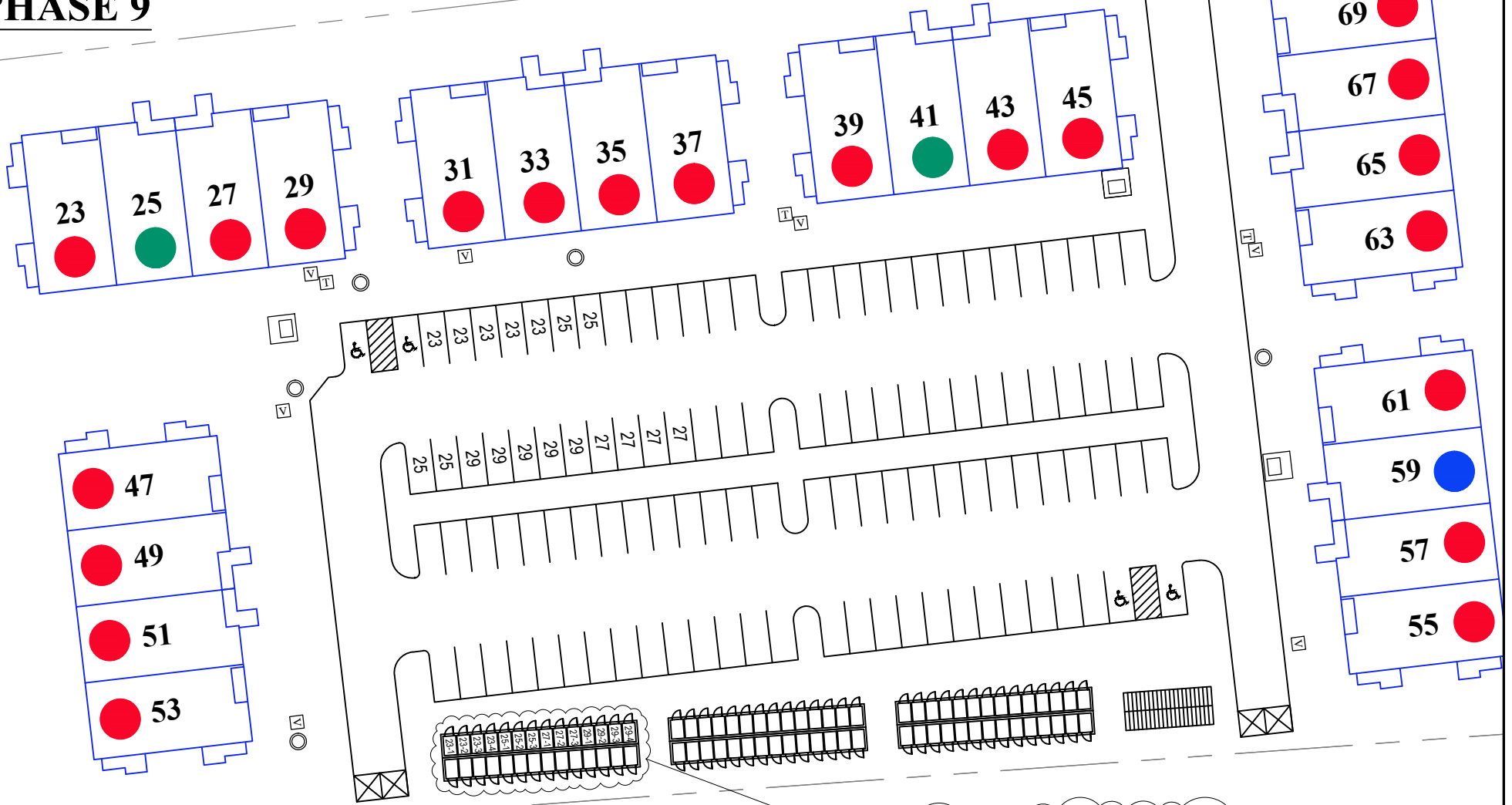

En signant le document, les clients confirment le choix de stationnements /
 By signing this document, customers confirm the choice of parking.

Client: _____

Client: _____

Date: _____

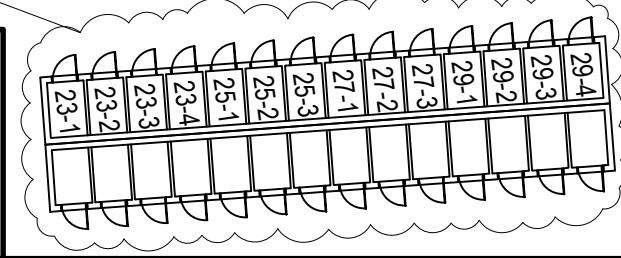

PHASE 9

LÉGENDES ÉLECT.

	TRANSFORMATEUR
	BOITE VIDEOTRON / BELL
	LAMPADAIRE
	COUVERCLE D'ACCÈS

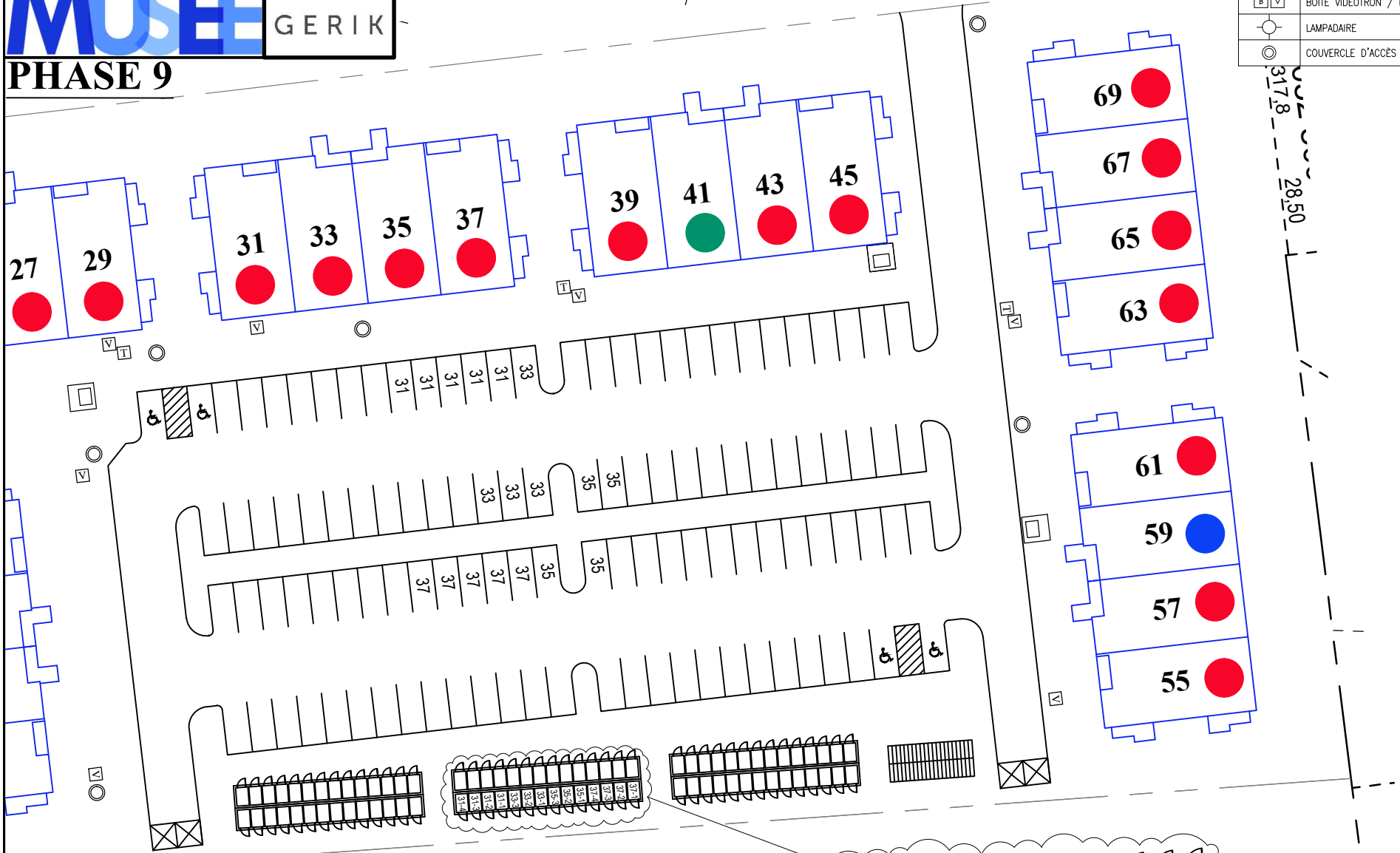

En signant le document, les clients confirment le choix de stationnements /
By signing this document, customers confirm the choice of parking.



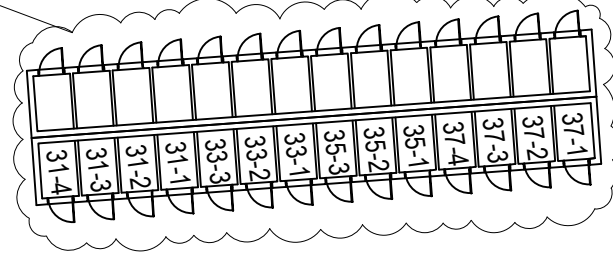

Client: _____

Client: _____

Date: _____



PHASE 9



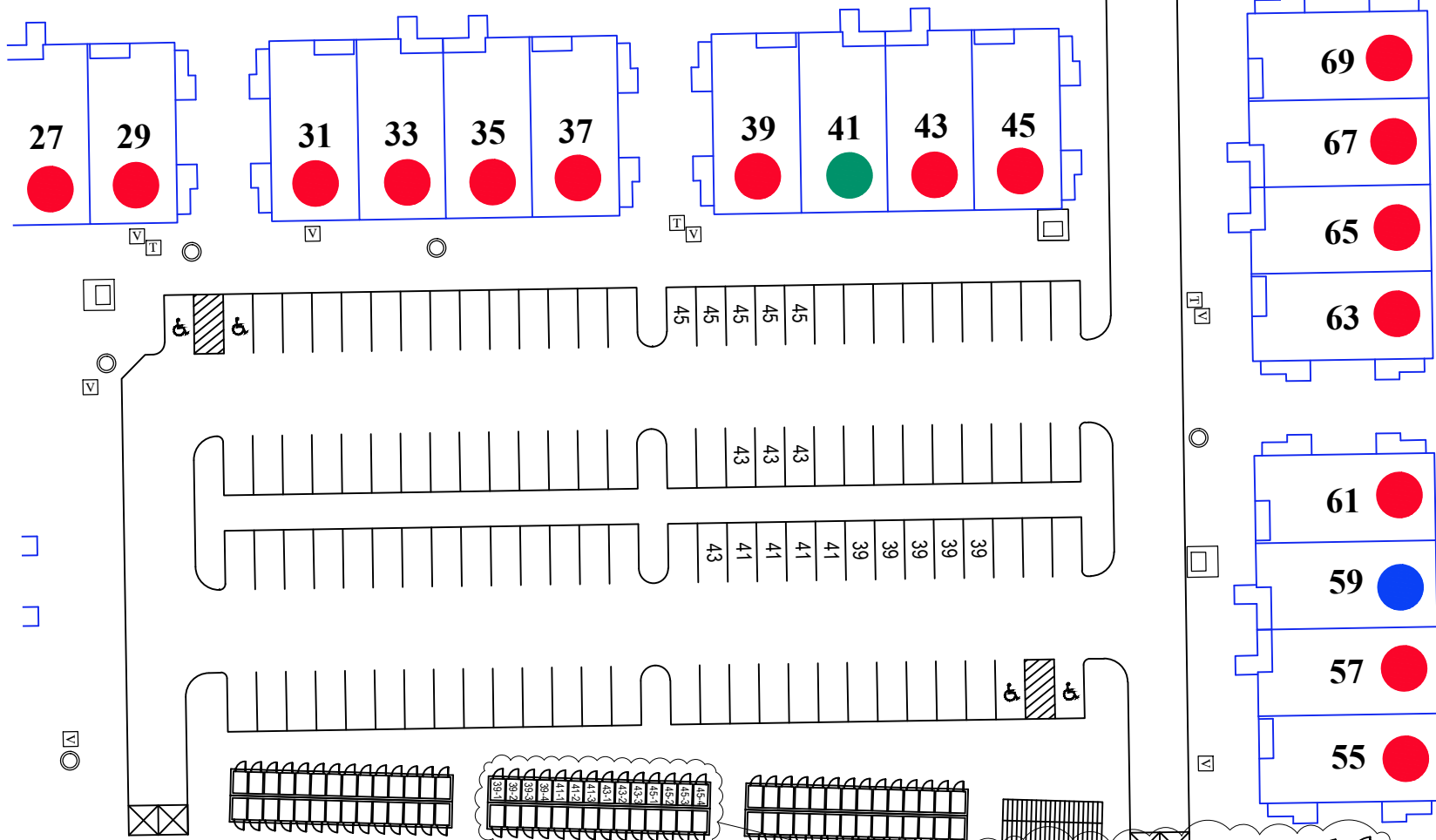

LÉGENDES ÉLECT.	
	TRANSFORMATEUR
	BOITE VIDEOTRON / BELL
	LAMPADAIRE
	COUVERCLE D'ACCÈS

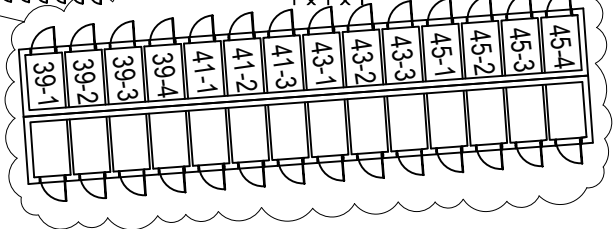

En signant le document, les clients confirment le choix de stationnements /
 By signing this document, customers confirm the choice of parking.

Client: _____
 Client: _____
 Date: _____



LÉGENDES ÉLECT.	
	TRANSFORMATEUR
	BOITE VIDEOTRON / BELL
	LAMPADAIRE
	COUVERCLE D'ACCÈS

PHASE 9

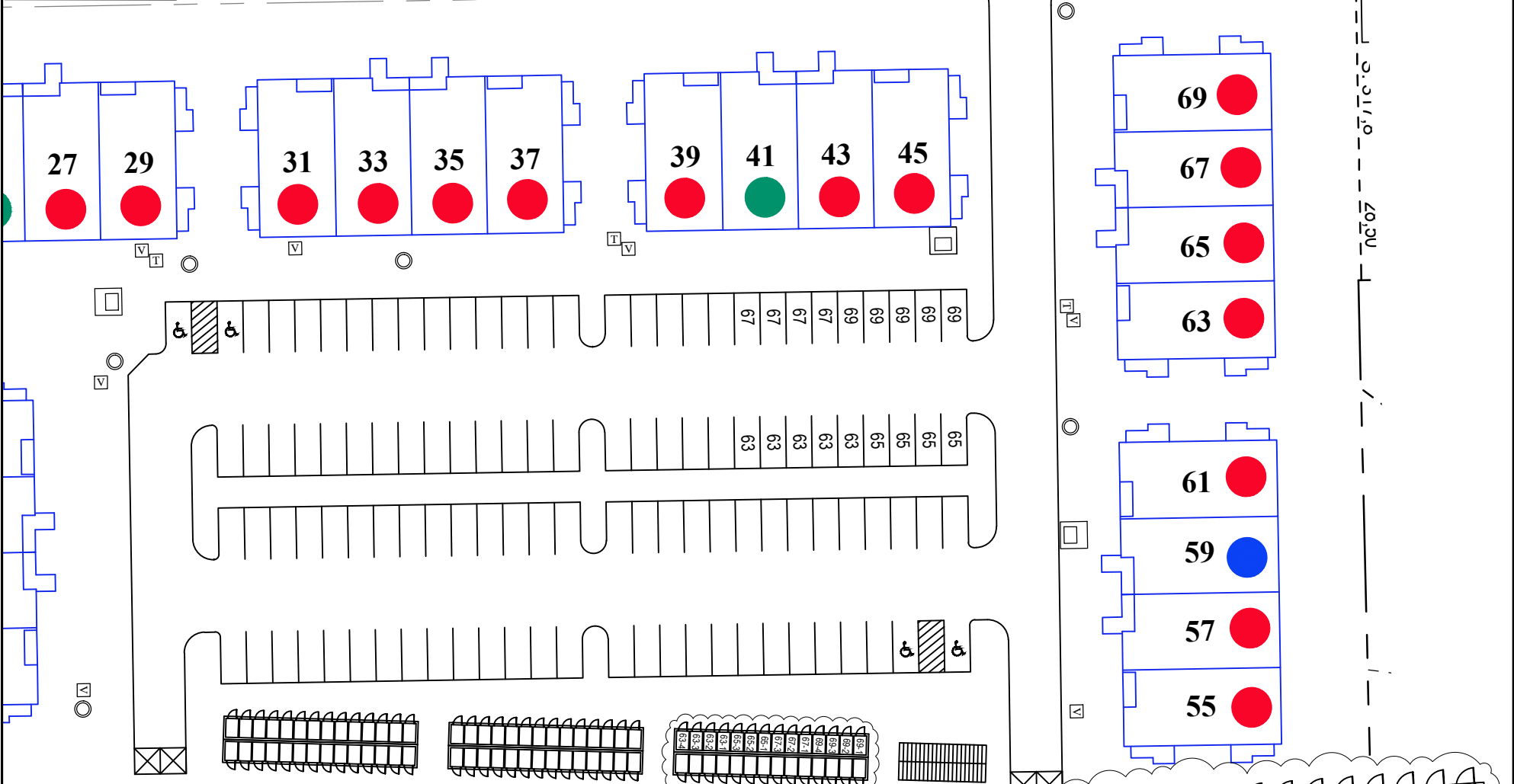





En signant le document, les clients confirment le choix de stationnements /
 By signing this document, customers confirm the choice of parking.

Client: _____

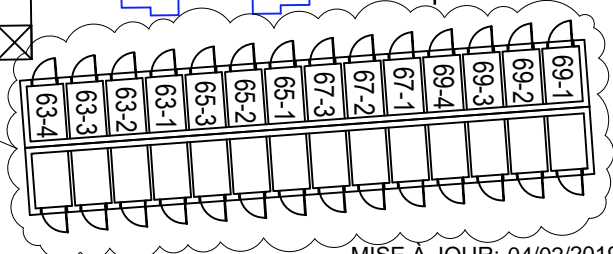
Client: _____

Date: _____



LÉGENDES ÉLECT.	
	TRANSFORMATEUR
	BOITE VIDEOTRON / BELL
	LAMPADAIRE
	COUVERCLE D'ACCÈS

PHASE 9

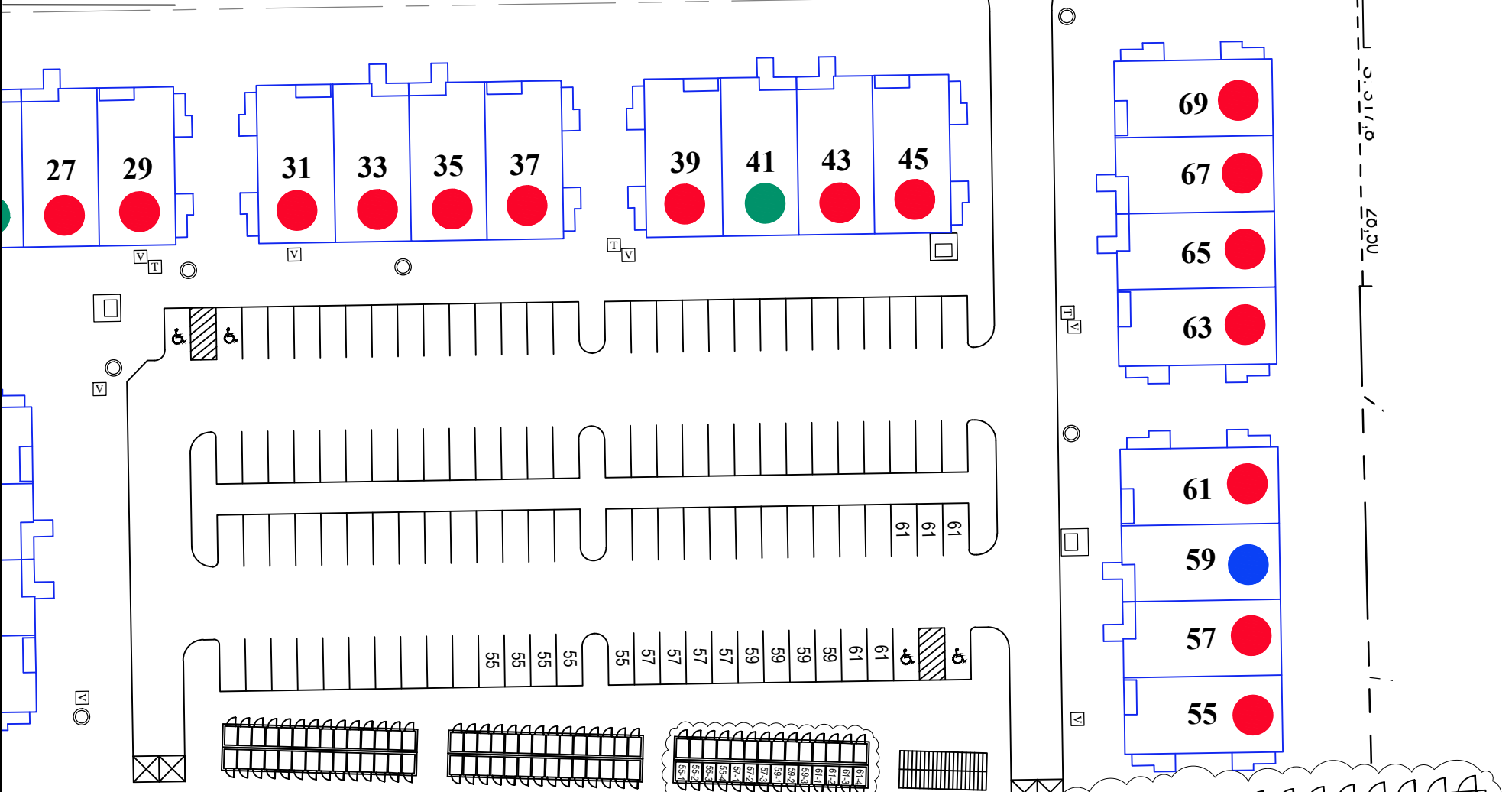

En signant le document, les clients confirment le choix de stationnements /
 By signing this document, customers confirm the choice of parking.

Client: _____

Client: _____

Date: _____

